

4

3

2

1

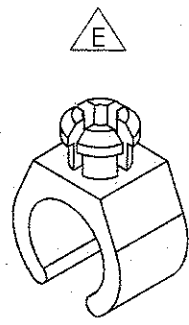

OPTION - 01

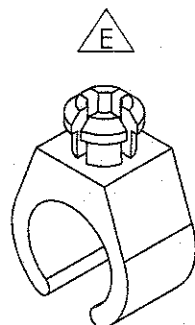

OPTION - 02

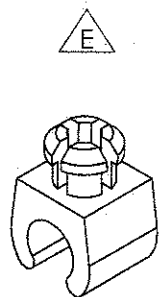

OPTION - 03

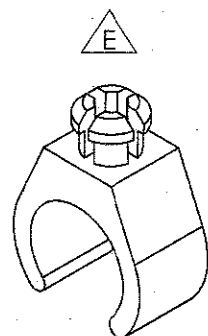

OPTION - 04

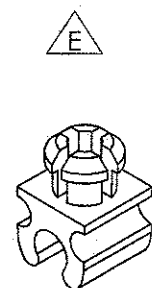

OPTION - 05

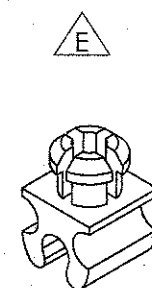

OPTION - 07 & 10

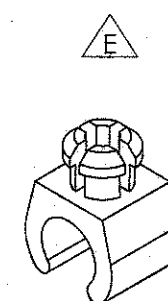

OPTION - 12

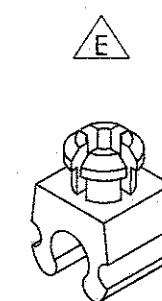

OPTION - 13

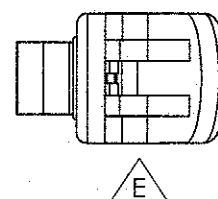
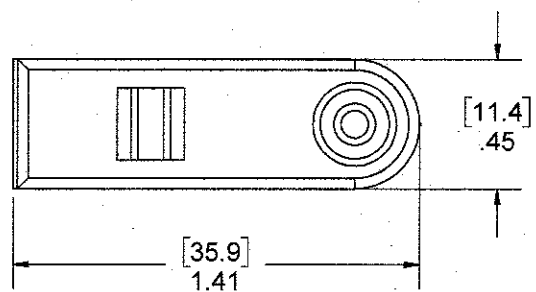
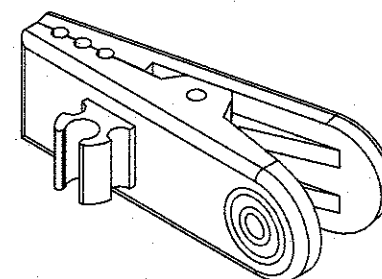
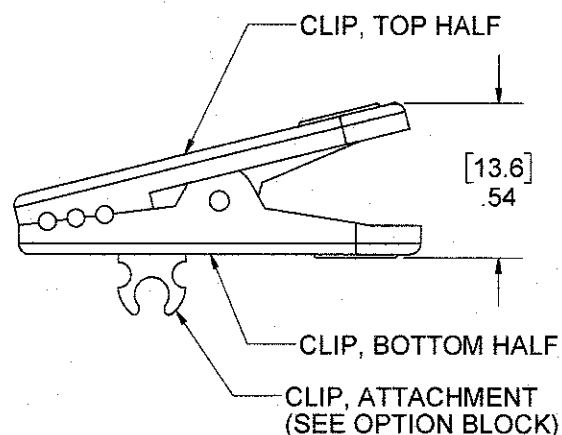

NOTE: METRIC DIMENSIONS IN PARENTHESIS

OPTION	CLIP ATTACHMENT	DRAWING
01	.285 ϕ	36615
02	.312 ϕ	36616
03	.173 ϕ	36617
04	.345 ϕ	36649
05	.120 ϕ	36650
06	.285 ϕ	36615
07	.100 ϕ	36840
08	NONE	-
10	.100 ϕ	36840
11	NONE	-
12	.200 ϕ	42173
13	.140 ϕ	42853

REV	DESCRIPTION	DATE	BY
E	REV PER ECO 33767, JLR, 5/17/19	6/4/19	CM
D	REV PER ECO 30387 XZ 12/1/17	12/10/17	TAB
C	REV PER ECO 26124 KDS 1/4/16	01/07/16	KG
B	REV PER ECO 24233 /BB 04/16/15	04/24/15	SLH
A	RELEASE PER ECO 23690 MJV 11/21/14	1-22-15	SLH
REVISIONS			

TOLERANCES UNLESS OTHERWISE SPECIFIED ALL DIMENSIONS IN INCHES - DIMENSIONS IN [] METRIC	
FRACTIONAL	$\pm 1/64$
DECIMAL	.00 $\pm .01$ [.25mm] .000 $\pm .005$ [.127mm]
ANGULAR	$\pm .5^\circ$

APPROVALS	DATE
DRAWN MJV	11/21/14
PROJ ENGR <i>[Signature]</i>	7/22/2020
APPROVED <i>[Signature]</i>	7/23/2020
PROJECT FSCM	

P Technologies
BECAUSE EVERYTHING CONNECTS
6591 Merriman Road, Roanoke, VA 24018
Phone: 540-772-7950 Fax: 540-989-7519

TITLE		ASSEMBLY, CLIP, LAPEL	
SCALE		2:1	
SIZE	DWG	REV	SHT
B	2574-50	E	1 OF 1

THIS DRAWING CONTAINS CONFIDENTIAL AND PROPRIETARY INFORMATION AND MAY NOT BE ISSUED OR REPRODUCED, IN WHOLE, OR IN PART, WITHOUT THE EXPRESS WRITTEN PERMISSION OF P1 TECHNOLOGIES.