

4

1

3

1

2

1

1

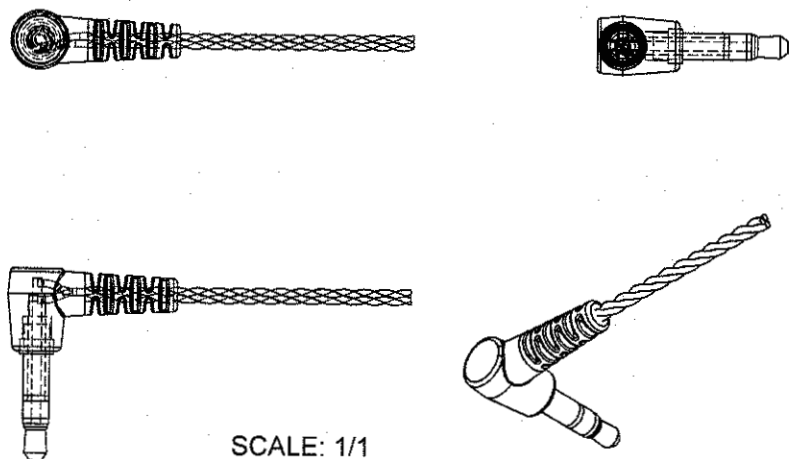

SCALE: 1/1

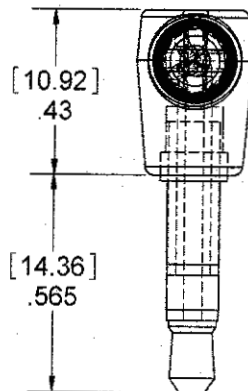
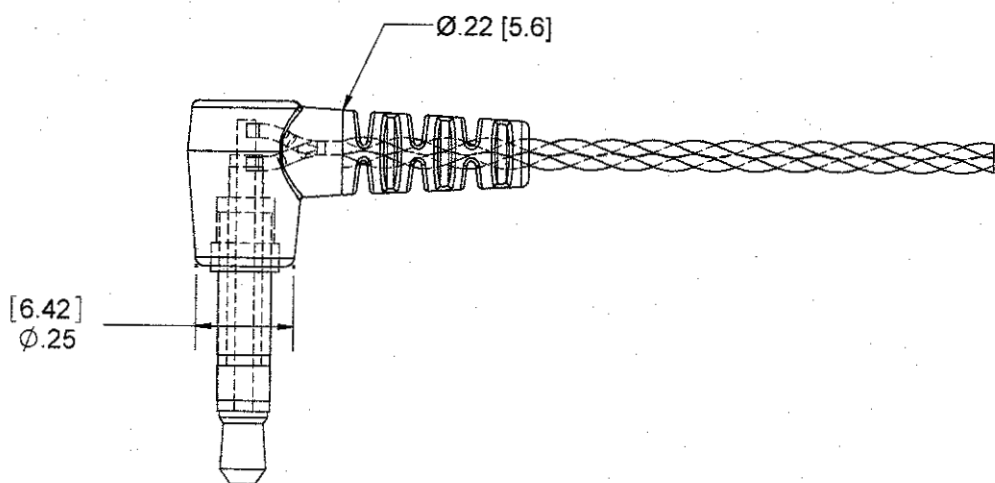
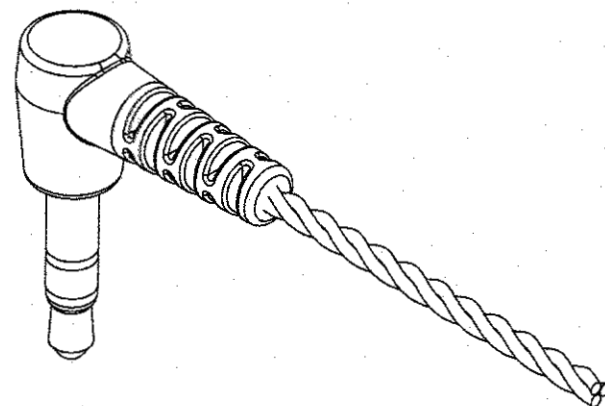

SCALE: 2/1

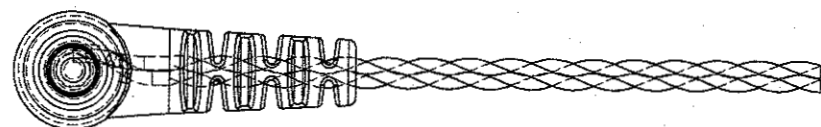
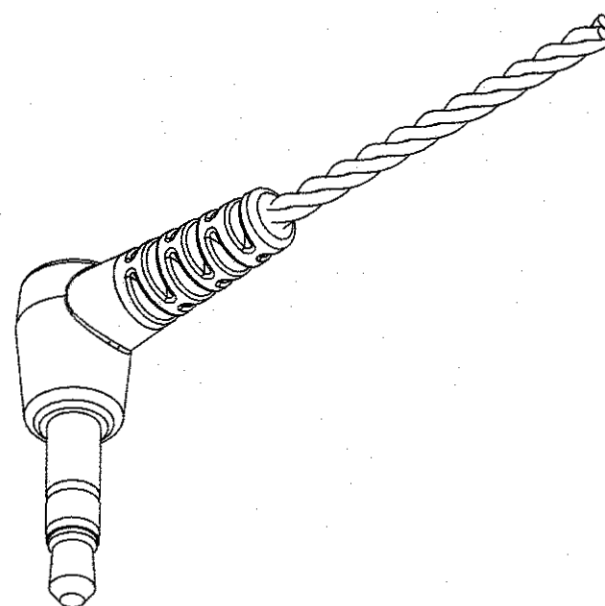

THIS DRAWING CONTAINS CONFIDENTIAL AND PROPRIETARY INFORMATION AND MAY NOT BE ISSUED OR REPRODUCED, IN WHOLE, OR IN PART, WITHOUT THE EXPRESS WRITTEN PERMISSION OF P1 TECHNOLOGIES.

REV	DESCRIPTION	DATE	BY
A	REL PER ECO 11799 JAP 3/5/2009	3/18/09	MK
REVISIONS			

<b>TOLERANCES</b> UNLESS OTHERWISE SPECIFIED ALL DIMENSIONS IN INCHES DIMENSIONS IN [ ] METRIC	APPROVALS	DATE	 <b>Technologies</b> <small>BECAUSE EVERYTHING CONNECTS</small> 6591 Merriman Road, Roanoke, VA: 24018 Phone: 540-772-7950 Fax: 540-989-7519
	DRAWN J PARKER	3/5/09	
	CHECKED <i>T. Stump</i>	7/14/20	
	PROJ ENGR		
<b>FRACTIONAL</b> $\pm 1/64$  <b>DECIMAL</b> .00 $\pm 0.01$ [.25mm] .000 $\pm 0.005$ [.127mm]	APPROVED <i>L. Spauldy</i>	7/16/2020	TITLE PLUG, 584, 3.5mm STEREO, RIGHT ANGLE
<b>ANGULAR</b> $\pm .5^\circ$	PROJECT 7535	FSCM	SCALE NOTED SIZE DWG. REV SHT <b>B</b> 40389-50 A 1 OF 1

D

C

B

A